

2017/2018



Library and Educational Furniture Catalogue





QUA-2017
FFFv2.1i-2010
Furniture, Fittings & Foam

Quantum Libraries achieves GECA certification for nearly 600 products
Quantum Libraries, has recently achieved certification with Good Environmental Choice Australia (GECA) for a staggering 598 products – a new record for the number of certified products for a single GECA licensee.

Front Page: Toowoomba City Library - Toowoomba Regional Council
Inside Page: St Clares Catholic College - Burdell



Contents

- CUSTOM FIT OUT P 4-9
- SERVICE COUNTERS P 10-13
- COMPUTER FURNITURE P 14, 15
- TABLES AND BOOTHS P 16-21
- CHAIRS P 22-25
- OTTOMANS P 26, 27
- STERLING - NEWSPAPER & MAGAZINES P 28, 29
- FURNITURE - DISPLAY STANDS P 30
- FURNITURE - DELUXE REVOLVING STANDS P 31
- NEWSPAPER & MAGAZINES P 32
- Q WALL DISPLAYS P 33-35
- CHECK-IN P 36-38, 41-43
- RETURN CONCEPT IDEAS P 39
- CHILDREN'S FURNITURE P 44-48
- BIG BOOK STORAGE P 49
- FURNITURE - STORAGE P 50, 51
- STEELCO - STEEL FILING CABINETS P 51
- TROLLEYS P 52-55
- MAKE-A-SPACE TROLLEYS P 55
- FLAT SCREEN TV TROLLEY P 56
- SIGNAGE P 57
- DISPLAY BOARDS P 58, 59
- COMMUNICATION BOARDS P 59
- EXPANDA - FLEXIBLE BROCHURE DISPLAY P 60
- BROCHURE DISPLAY SYSTEM P 61
- GLASS DISPLAY CABINETS P 62, 63



Our Guarantee



All items with this seal are custom designed and manufactured by Quantum in Australia using Green Australian products

10 Year Warranty



All items with this seal are manufactured by Quantum in Australia using Green Australian products

10 Year Warranty



All items with this mark are manufactured by Hydestor New Zealand using Australian and New Zealand Green Listed products

5 Year Warranty



All items with this mark are manufactured in Asia and have been inspected and approved by FURNTECH - AFRDI based on Australian and New Zealand Standards

5 Year Warranty

Custom Fitout



With the combination of Quantum Libraries - Quantum Engineering & Quantum Custom Joinery.

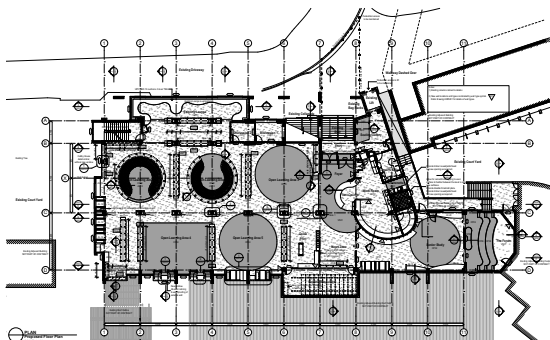

Concept Drawing

Custom Fitout



Quantum Libraries can provide a successful outcome - using your plan or ours!

1. Sterling Casing With Hydestor Adjustable Shelves
2. Q-Wall custom size (page 33)
3. Custom OPAC (open public access computer)
4. Curved Shelving
5. Forum Seating
6. Ottomans (page 26)
7. Base Uptilt Shelving

Custom Fitout



1. Roll Away reading Nook with Integrated shelving
2. Custom Built Roll Away book Shelving
3. Roll Away Curved Ottoman (page 46)
4. Roll Away Curved Easy reader bin (page 46)

Kawana Waters Library - Sunshine Coast Libraries

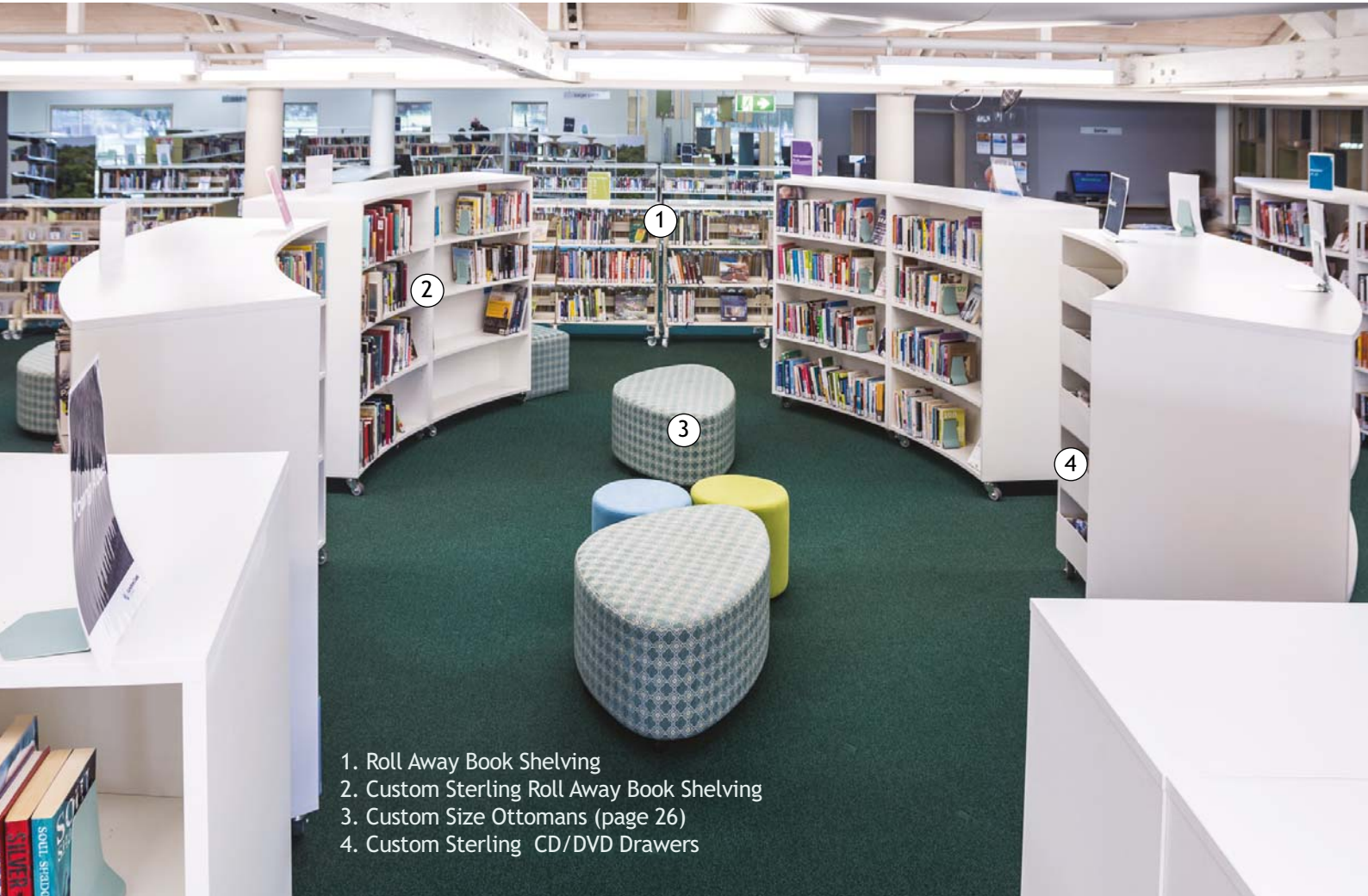

1. Roll Away Book Shelving
2. Custom Sterling Roll Away Book Shelving
3. Custom Size Ottomans (page 26)
4. Custom Sterling CD/DVD Drawers

Kawana Waters Library - Sunshine Coast Libraries

Custom Fitout

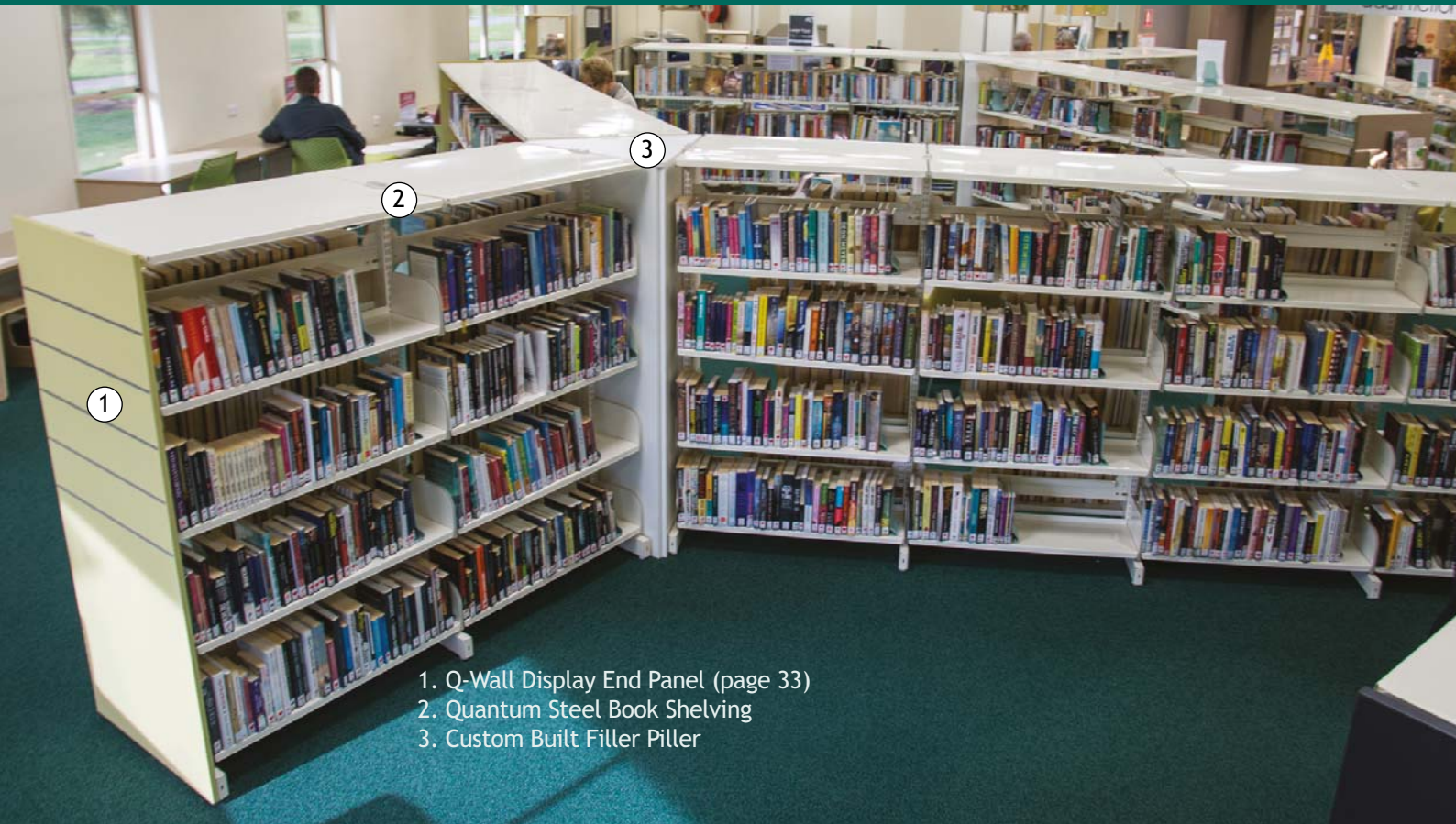

1. Q-Wall Display End Panel (page 33)
2. Quantum Steel Book Shelving
3. Custom Built Filler Pillar

Kawana Waters Library - Sunshine Coast Libraries



1. Custom Built End panel with solid timber edges
2. Steel Sign Holders (page 57)
3. Q-wall slats integrated into panel for display (page 33)
4. Q-wall pillar wrap (page 34)

Toowoomba City Library - Toowoomba Regional Council

Custom Fitout



1. Reading Cubbie with cushion seat
2. Sterling Shelving unit. (Combination of timber board and Steel shelving)

St Clare's Catholic School - Burdell

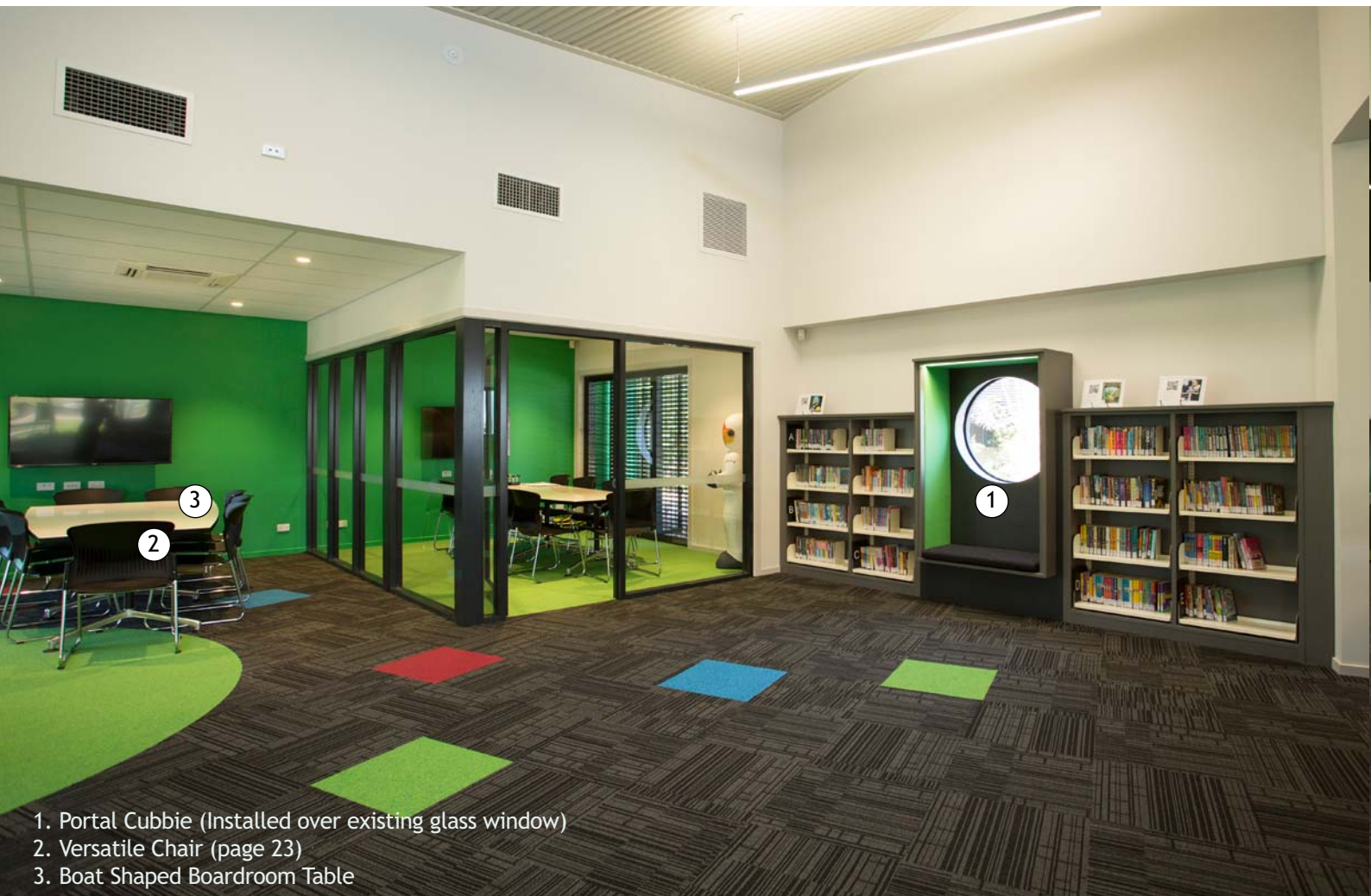

1. Portal Cubbie (Installed over existing glass window)
2. Versatile Chair (page 23)
3. Boat Shaped Boardroom Table

St Clare's Catholic School - Burdell

Custom Fitout



1. Custom Built Ottoman (page 26)
2. Portal Cubbie (Installed over existing glass window)
3. Sterling Mobile Book Shelving with lockable castors
4. Reading Cubbie

St Clare's Catholic School - Burdell



1. Q-Wall Panel for versatile display options (page 33)
2. Sterling Roll Away Shelving with lockable castors
3. Sterling wall mount shelving
4. Reading Cubbie

St Clare's Catholic School - Burdell

Service Counters



Height Adjustable Service Pods - From 700mm up to 1.2m high. Sizes - designs - finish to suit your library.
Pictured at University of Queensland - HI-MACS® solid surface tops with laminated base and a 3mm aluminium surround to accept graphics.

N.B. After years of wear and tear - tops can be sanded back to new and graphics can be changed to create a fresh new look at minimal cost. We use only use Linak actuators for our electronic height adjustment - a trouble free product made in Denmark.



Service Counters

Part static and part height adjustable

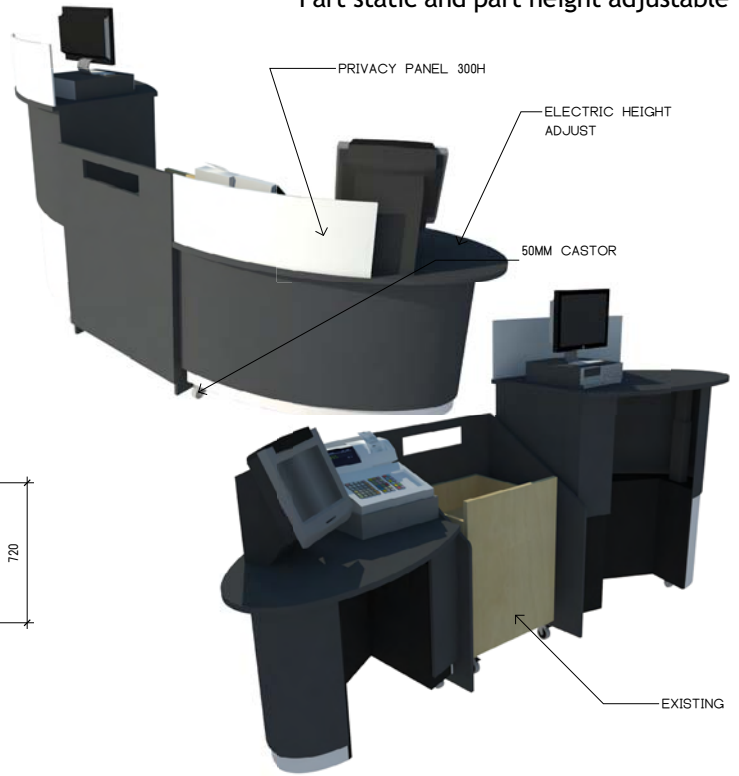
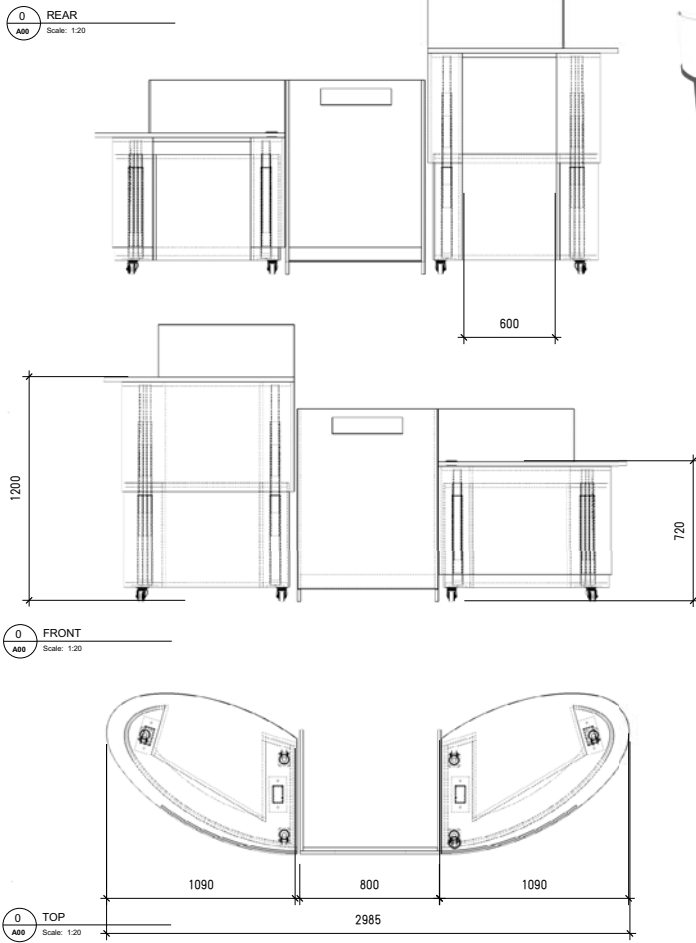

Quantum Libraries have the experience to understand what is required for your workstations.



1. Electronic Height adjustable end section
2. Custom vinyl wrapping
3. Fixed Position Center Piece



Service Counters



St Clare's Catholic School - Burdell



Sunny Bank High School



Quantum Libraries can design and build your circulation counter



Unity College - Caloundra

Service Counters



Design/built counter for Faith Lutheran College, Victoria Point, Brisbane.



Design/built counter for Suncoast Christian College.

1. Hot Metal Front panel
2. Integrated LED
3. School Emblem incorporated into final design

Computer Furniture



Laptop tables - sizes and shapes made to order.



Laptop benches with charging facilities - made to order - enquire about the new Elsafe Pixel points with GPO and USB points (the Elsafe Tuff charger USB will deliver 5 amps) for charging.

Built in computer area with lockable drive boxes.



Computer Furniture



Shapes, sizes, colours - designs - Quantum can create something to suit your library.

Computer PODs



Tables & Booths



Tables



Booth Seating

Tables & Booths



1/4 Circle Table

All Quantum tables made to order. Select sizes, shapes, melamines, laminate - stone, powdercoat colours for frames.



Flip-Top Tables

Tables & Booths



Booth seating made to order

Whiteboard tables made to order

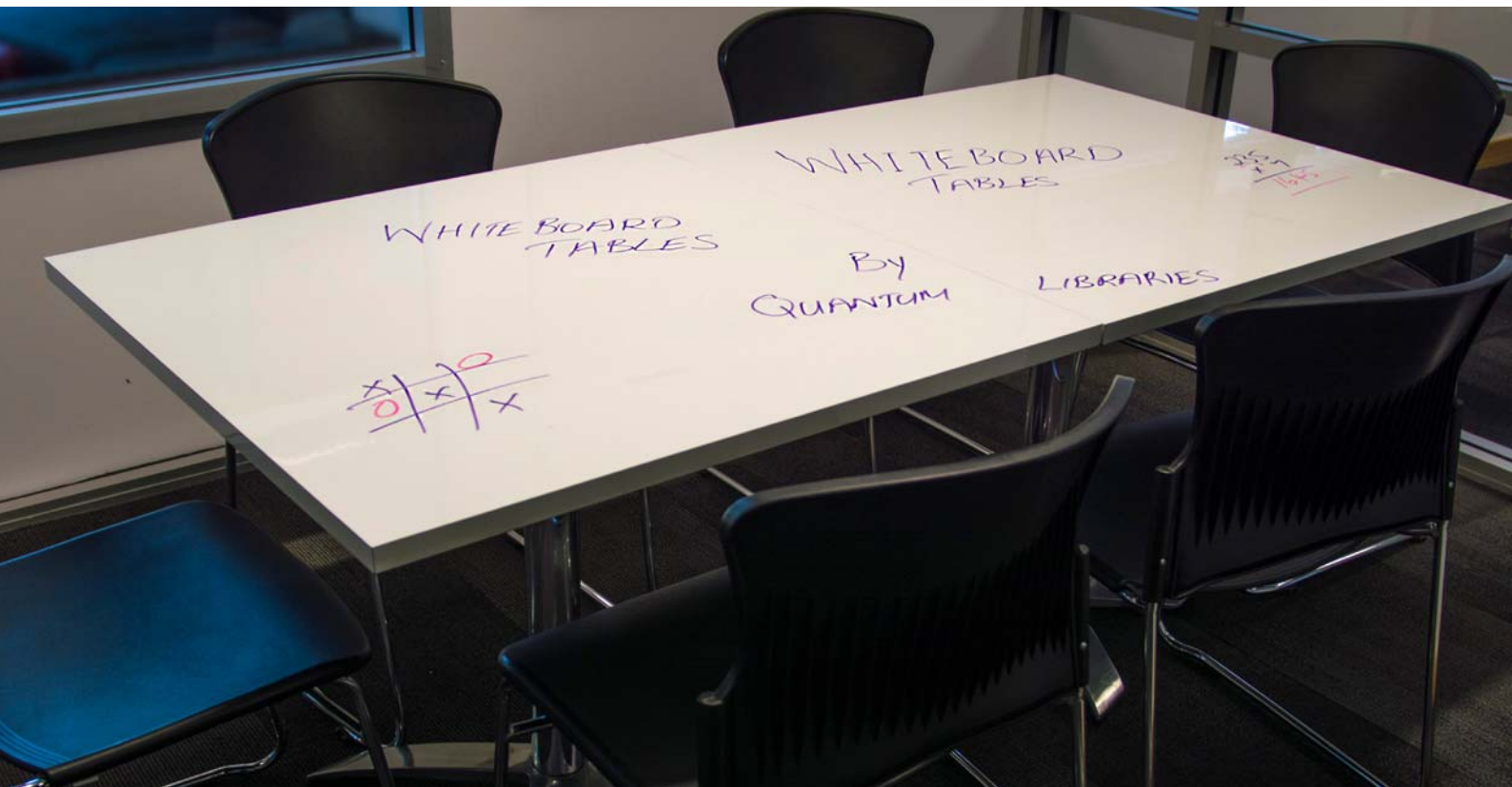

Tables & Booths



15 seater ottoman seating with 15 powered laptop table incorporated. Quantum make a large range of table shapes in selected sizes and colours. If you don't see what you want we can custom design a product for suited to your needs

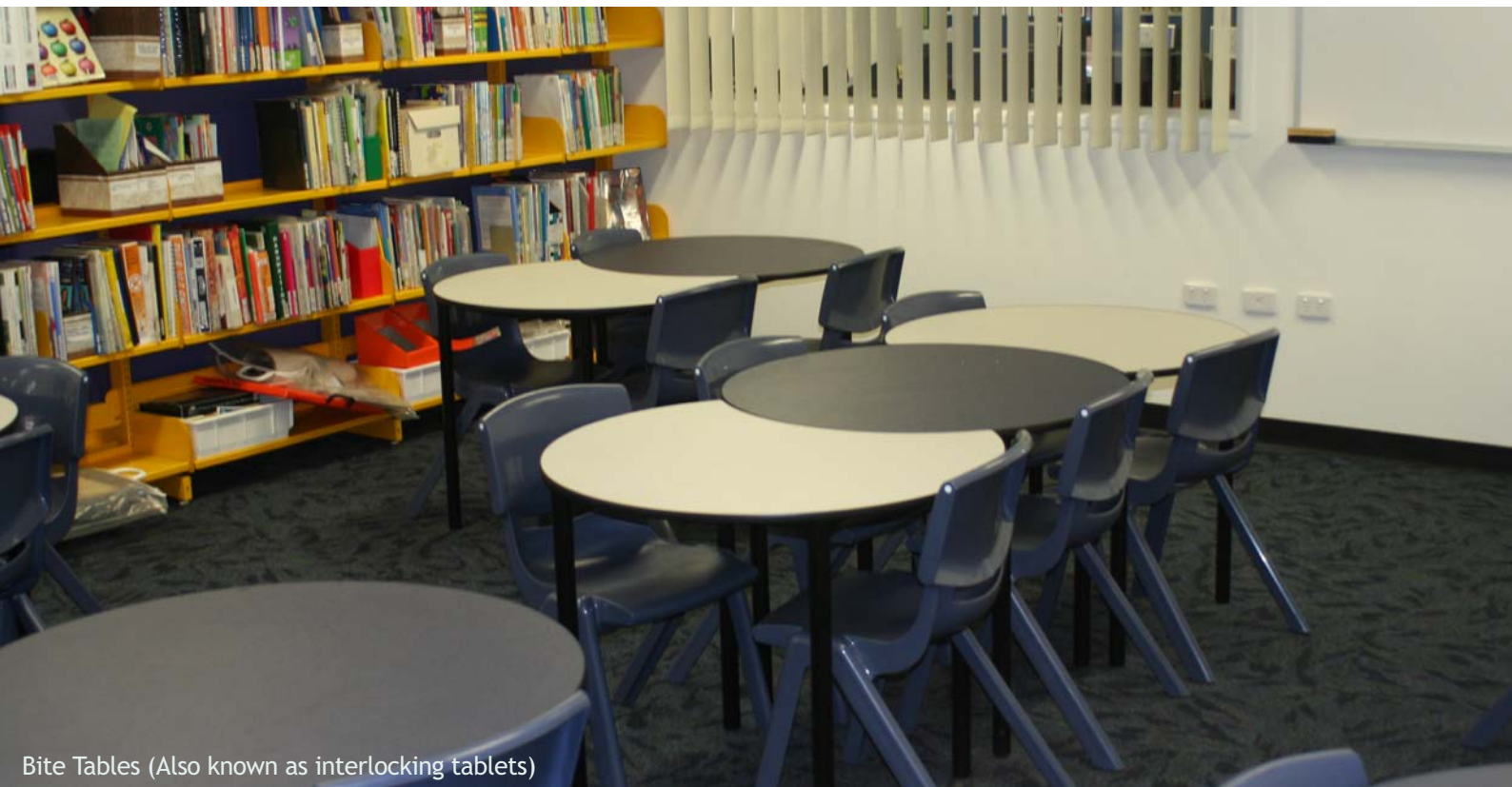

Bite Tables (Also known as interlocking tablets)

Tables & Booths



Mobile Curved Easy Reading Boxes with integrated seating



Children's Table and Stools

Tables & Booths



Custom Built Tables and Ottomans

Roll Away Reading Nook with integrated shelving



Chairs



Chinque High Back



Candy-Task



Sturdy Mesh



K9X5378



Penny Drafting



Budget MB



Goblin High Back



Clover Stool



SE3



BXM



MR30- Chair



Mia Medium Back

Chairs



ELKE Stacker



Burchell



Villu Sled



Web Mesh



Cafe 5



Snip Training



Candy 4 Leg



Imesh Catilever



Cello



Mandarin



Chocolate



White



Black



Lime



Moccha



Red



Blue



Upholstered Versatiles (select upholstery available)

Chairs



Hamilton with Arms



Momo with Arms



Alyssa 3 Seater



Regent Tub



Hamilton no Arms



Broadway Tub



Broadway 2 Seater



Alyssa Tub



Brook Single



Brook Double

Versatile Chairs and Understage by Quantum

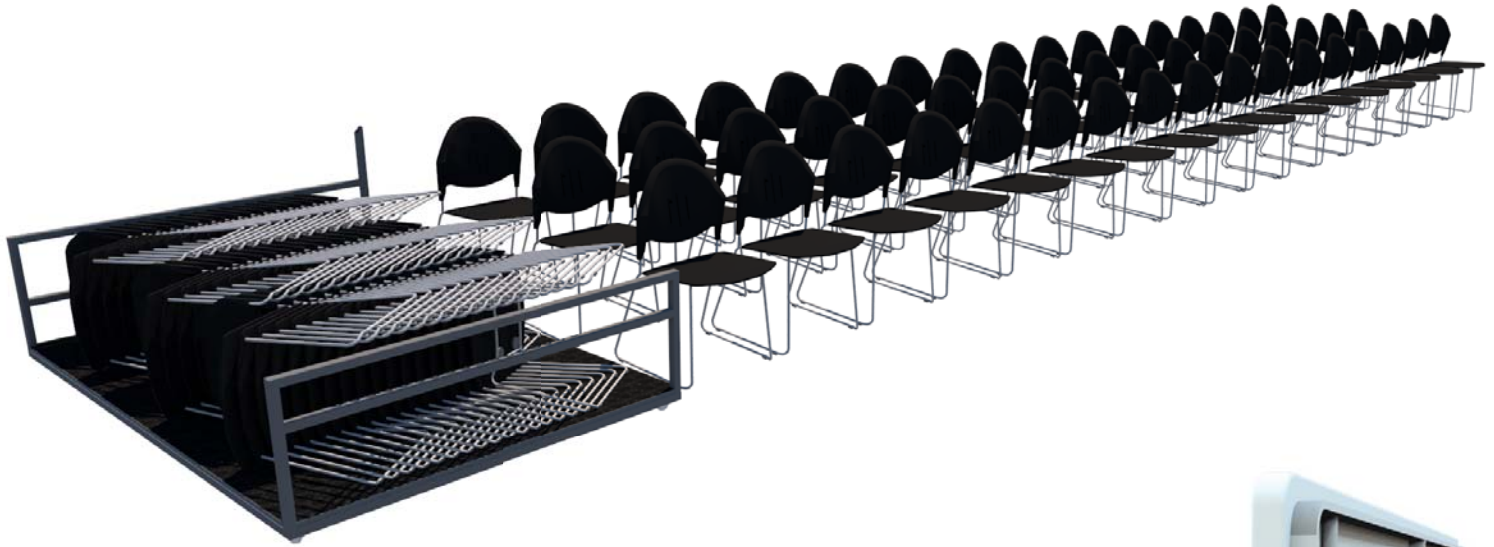

Understage is designed and built by Quantum Libraries

Understage is custom built to suit your needs, We make to order and can customize to suit your requirements. Quantum Libraries recommend the Versatile chairs with the Understage trolleys.

Ottomans



Blok 1



Blok 5



Trapezium



Nik Nak

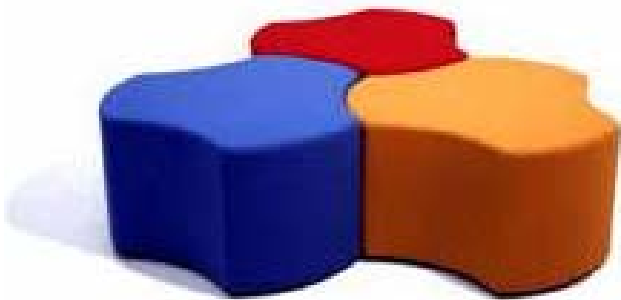

Clover



Jumble



Small & Large Round



Ottomans



Missoni Square



Tables are custom built to suit your needs and can be made to varying height



Missoni Round



Glow Lounge with back

Glow Lounge - no back



Curve



Round

Large range of custom colours and fabrics available. Check our website or speak to one of our Representatives for price and availability.



Round & Teardrop

Sterling - Newspapers & Magazines



Sterling Magazine Display/Storage built to suit area.

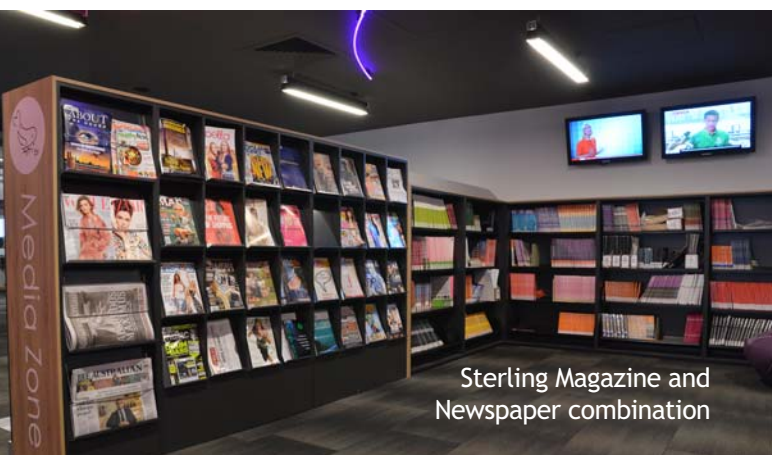

Sterling Magazine and Newspaper combination



Sterling Magazine Display/Storage

Sterling - Newspapers & Magazines



Sterling Book, Magazine & Newspaper Shelves combination



Sterling Units with Q Wall Display backs

Sterling Book, Magazine & Newspaper Shelving - made to any configuration (bottom left)

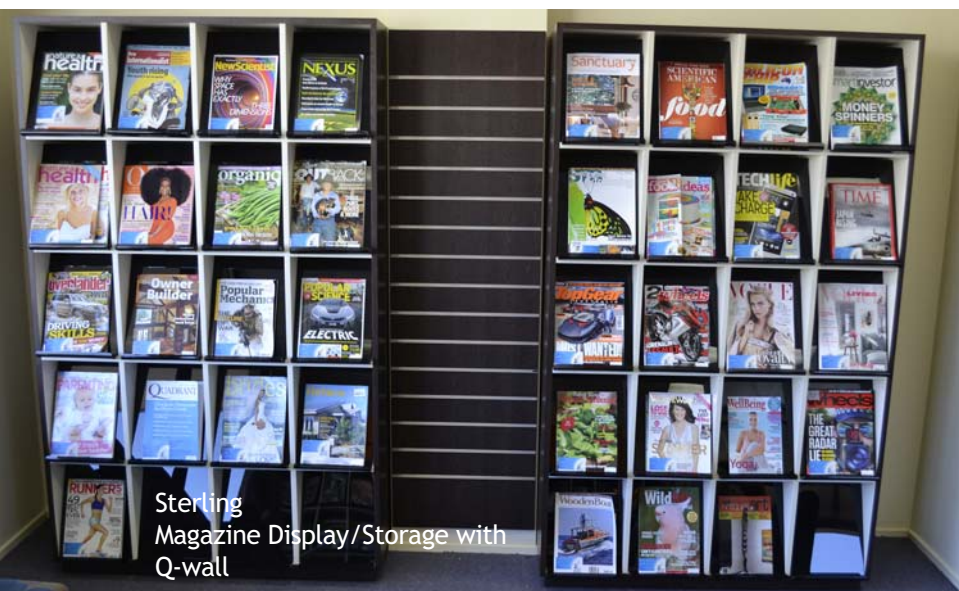

Sterling Magazine Display/Storage with Q-wall



Sterling Newspaper Display/Storage

Furniture - Display Stands

Unless Specified, furniture will be supplied in beech. Red, Blue, Yellow, multi coloured, of White or Grey available at no extra charge.



Display Cubes
Dimensions:
 500mmH x 500mmW x 500mmD

All units shown are available in a wide range of Front Runner fabric colours or Melamine finishes including timber grain.

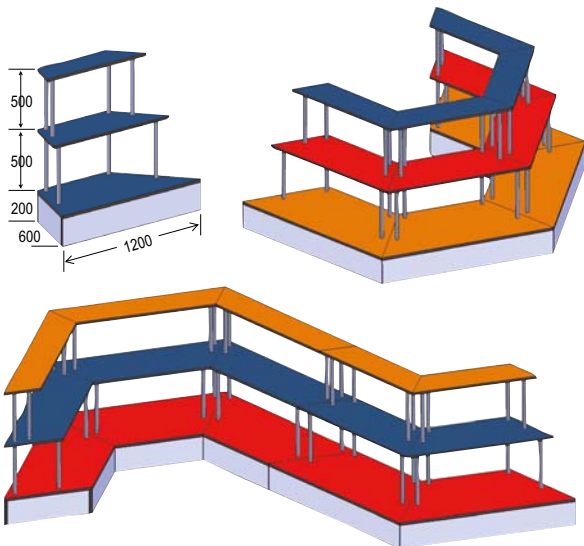
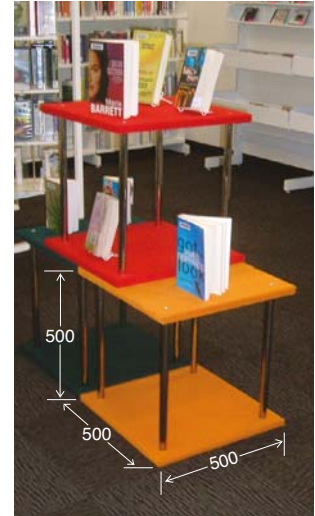

DISPLAY TRAPEZIUMS
 Fabric Covered CS3102
 Melamine CS3103

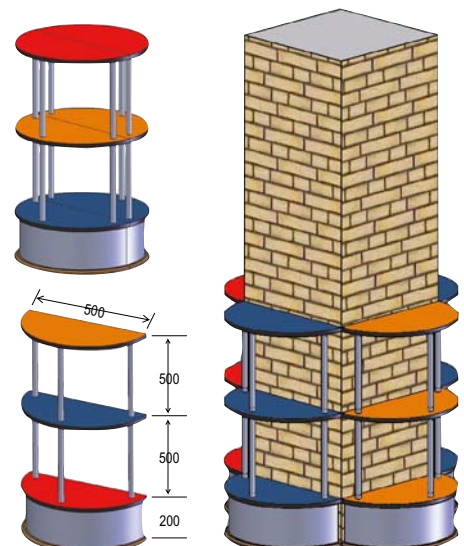

DISPLAY CRESCENTS
Dimensions: 1200mmH x 600mmW x 300mmD
 Fabric Covered CS3104
 Melamine CS3105



PYRAMID BOOK DISPLAY UNIT FC1152
 4 sided corner unit
 1050mmH x 900mmW x 900mmD

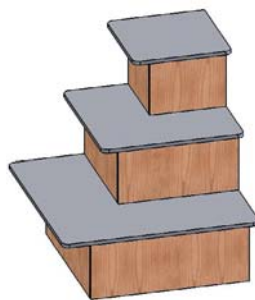

PYRAMID BOOK DISPLAY UNIT FC1154
 2 sided corner unit
 1050mmH x 900mmW x 900mmD



PYRAMID BOOK DISPLAY UNIT FC1153
 3 sided wall unit
 1050mmH x 600mmW x 900mmD

Custom board colours and ABS edging available.
 Check our website or speak to one of our Representatives for price and availability.

Furniture - Deluxe Revolving Stands

- Each frame is 1700mmH x 600mmW.
- Available in either Timber or Powder coated metal frame.
- Requires 2 frames for free standing units.
- Single frames may be purchased to add to existing frames.
- 4 or 5 tier available.



LARGE PAPERBACK FC1354
 4 Tier Spinner - 3 frames shown
 305mmH X 135mmW X 135mmD
 Holds approx 80 books



PAPERBACK/VIDEO FC1353
 5 Tier Spinner - 2 frames shown
 240mmH x 135mmW x 135mmD
 Holds approx 80 videos.



CD TOWER FC1352
 7 Tier Spinner - 3 frames shown
 165mmH x 135mmW x 135mmD
 Holds approx 224 CD's



DELUXE REVOLVING METAL FRAME FC1356
 Pictured with 5 Tier Paperback Spinners.
 4 frames shown.
 Frames can be powder coated to almost any Dulux colour. Subject to availability.

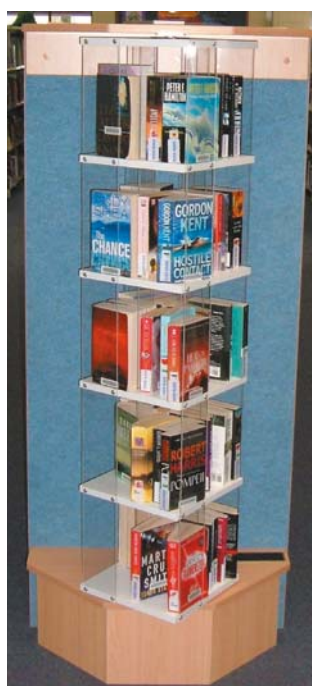

DELUXE REVOLVING ENDPANEL FC1357
 Spinner - 1575mmH x 680mmW x 400mmD
 Pictured with a 5 Tier Paperback Spinner.
 Can be supplied with or without fabric covered Back Panel.



CHILDRENS REVOLVING STAND FC1355
 1700mmH x 410mmW x 410mmD
 4 Tier Large Paperback Spinner.
 Wide range of Melamine colours available.

Newspapers & Magazines



Wallmounted 7 Tier Newspaper Rack
 1300mmH x 380mmW x 90mmD
 W19090



7 Tier Double Sided Newspaper Mobile Stand
 (Black Only)1675mmH x 400mmW x 500mmD
 FS2170



7 Tier Single Sided Newspaper Stand
 Integrate with Library shelving
 1875mmh x 900mmW x 375mmD



Newspaper/Dictionary/Atlas Stand FC1030
 900mmH x 600mmW x 450mmD
 Supplied with 4 adjustable shelves.
 Shown using 2 shelves.



Custom Newspaper/Dictionary/Atlas Stand
 2 bay unit with 4 adjustable shelves.



Custom Newspaper/Dictionary/Atlas Stand
 With half clear top and clear shelves.



Sterling Newspaper Stand - FC2171
 Four issues on display with storage behind
 Made to order custom colours available
 1800mmH x 486mmW x 450mmD



ZIGZAG NEWSPAPER DISPLAY FC10010
 Displays up to 6 newspapers
 1700mmH x 500mmW x 500mmD

Perspex Newspaper Holders also available as Combination Newspaper and Display Stand

FC1024



500mm W x 500mm D

1.6 metre H

QWall Displays



Custom made QWall Display Stands and Wall Mount Panels - sizes and colours on request.



QWall Display with lockable cupboard underneath

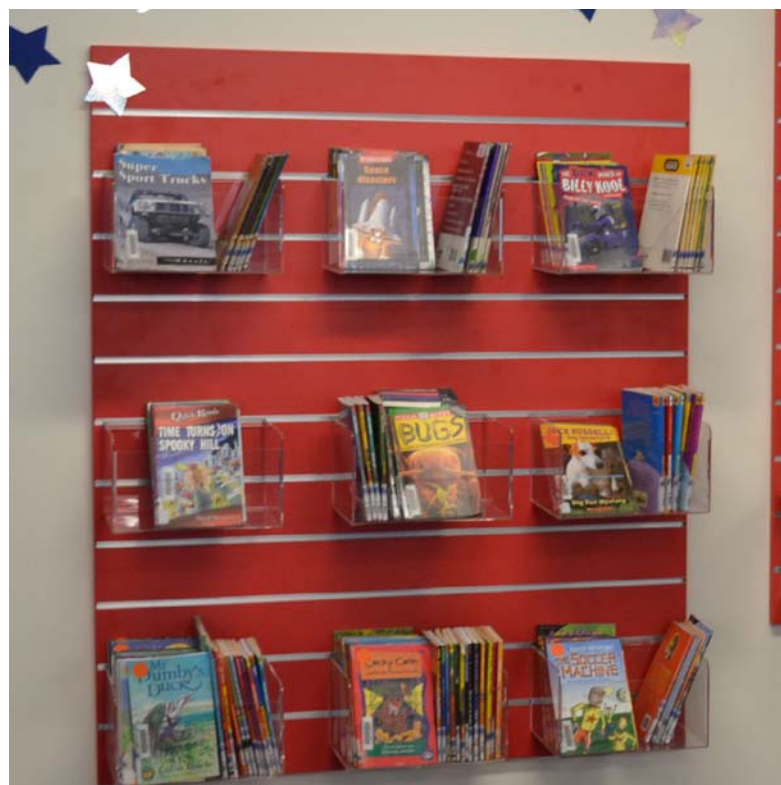

QWall Displays



QWall Display - designed to cover pillars and unsightly building features



QWall Panels made to size

QWall Displays

Cover Up unsightly areas with cost effective QWall Panels



Before



After

Check-In



Compact sorter with three bin sort - E.M. or RFID controlled.



Old chutes covered and entrance modified by Quantum Libraries

Check-In



1. Stainless steel fascia with angled chute to (3) accomodate angled bench and bin.
2. PG50 Security Gates - RFID



3. Built-in "E" bin for fast clearing - WPH&S friendly.

Check-In

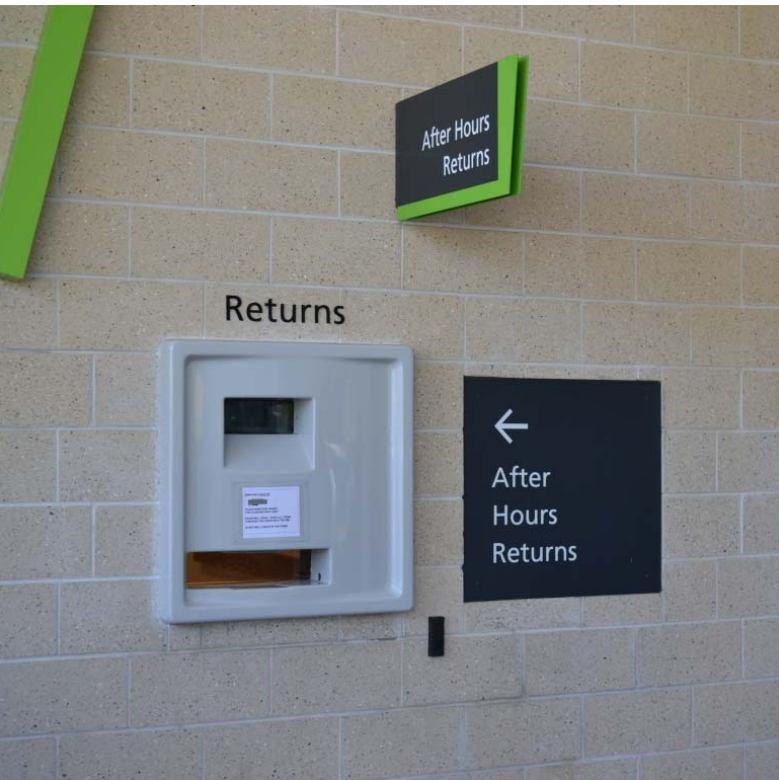

Controlled access chutes - barcode/RFID/Hybrid

Manual and Auto Lock Off Chutes



Motorised “E” bin has a large capacity (4 std. spring loaded bins) motorised is ideal for distances - comes with its own docking station for recharging.



Mobile “E” bins with email or pager alerts, to notify when a bin is ready to be emptied (you don’t need to hang around the returns room waiting).

Libretto Bins can be configured for 2 to 250 bins

Return Concept Ideas

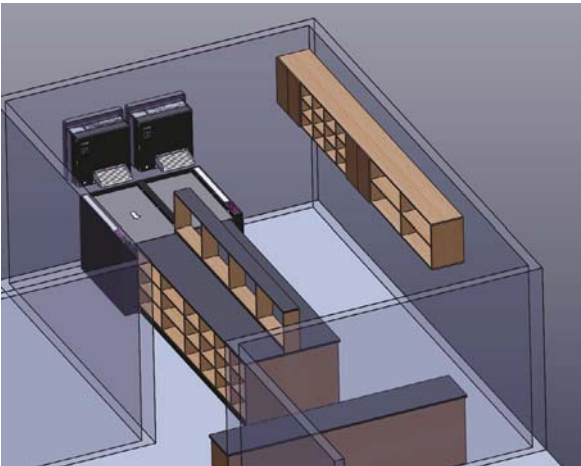

Beerwah from draft to the finished product



Outside

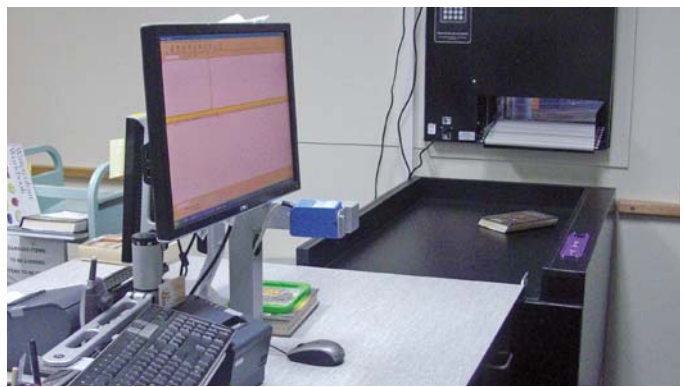

Inside

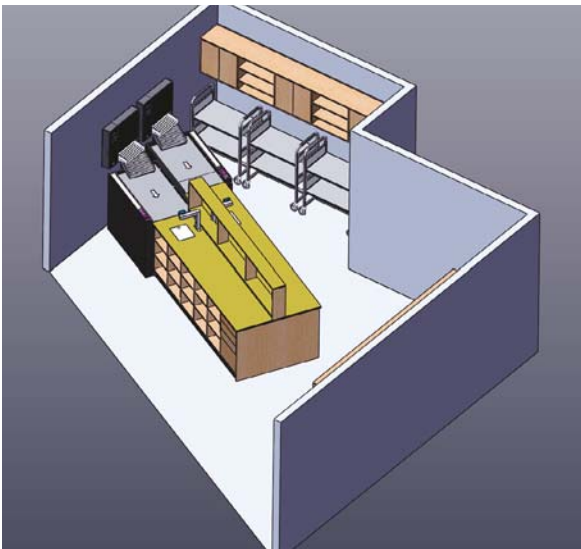

Nambour from draft to the finished product

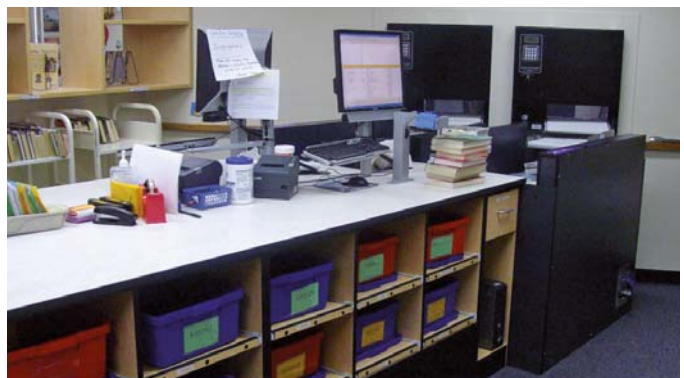

Check-In

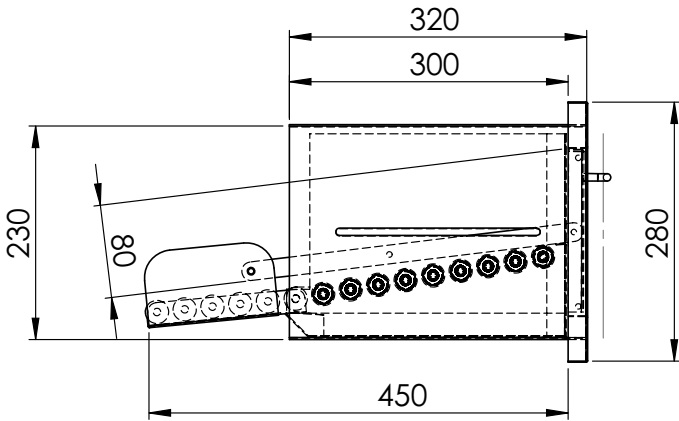

FB4204L - Secure Return Chute With Key Lock



Custom Weatherguard

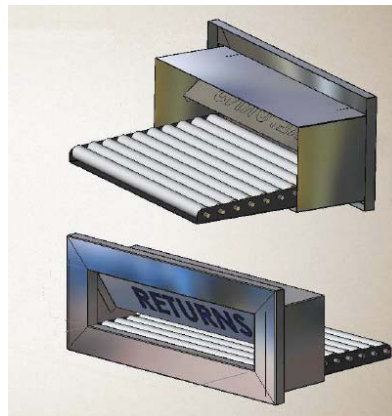

Internal Needle Roller Chute
FB4209
Signage optional extra.
Also available without flap FB4213

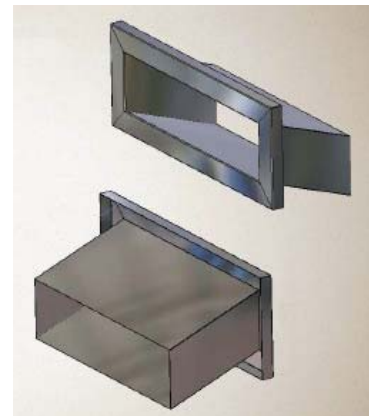

Wall Shute - FB4207
No flap for installations through desk or wall chute.



Customised chutes built for specific situations.



Pictured through glass wall.

Check-In



RFID ACTIVATED OUTSIDE RETURNS BIN

Any book with an RFID tag will activate the door
(low voltage power for safety)
1650mmH x 800mmW x 980mmD



LARGE OUTSIDE RETURNS BIN

FS2001
1600mmH x 900mmW x 1200mm D



SMALL OUTSIDE RETURNS BIN

FS2006
1500mmH x 732mmW x 875mm D
Small Metal Dump Trolley TR2601
Sold Separately - Details below.



LARGE METAL DUMP TROLLEY

TR2600
1050mm x 750mm x 830 High
The large trolley is normally supplied with the large outside bin but is available separately.
Capacity is approximately equal to 3 Timber Dump Trolleys.



TIMBER DUMP TROLLEY

TR1100
775mmH at back, 675mmH at front
X 600mmW x 560mmD

LOCKABLE DUMP TROLLEY

CUPBOARD FC1100
1108mmH X 802mmW X 650mmD
Returns Slot is 390mm x 75mm
Doors are 800mmH. Sold Separately.



SMALL METAL DUMP TROLLEY

TR2601
600mm x 650mm x 750mm High
The small trolley is normally supplied with the small outside bin (pictured right) but is available separately.
Capacity is approximately 1.5 Timber Dump Trolleys.

Check-In



For larger organisations receiving quantities of books in cartons: The courier simply places cartons on the roller conveyor - they are then just pushed up to the work bench for processing. Roller conveyors can be made in different shapes - should you want them to travel around the wall to meet up with a bench - no problem - we're happy to provide return solutions for you.



Library Mate - consists of a lifter system either beside or built into the bench. The courier places the cartons or tubs on a smart pallet whereby they are loaded onto the Library Mate with a porters trolley OR / The courier can drop the cartons or tubs onto the special trolley - the trolley is wheeled into the Library Mate where the trolley is lifted up until the top tub is at working height - the empty tub is discarded then it lifts up the number two and so on.

Check-In



Automated Internal Returns (RFID)

Automated check-in After Hours or during hours. The RFID controlled door opens up when the book is presented - the book is then checked in - reactivated security - then sorted into three different bins.



External Returns (RFID)

The counter at Jimboomba has been altered to accept an electronic “E” bin - Quantum have altered the counter - installed the “E” bin and provided a privacy panel that lets the staff see who’s coming but at the same time they have complete privacy.



Patron/Client View



Staff view out



Children's Furniture



Quantum Libraries
can build to suit
your theme



Children's Furniture



Most of Quantum Libraries's furniture designs come from customer requests. If you imagine it, we can build it.



Children's Furniture



Lilly Pad and Trolley - Custom colours and fabrics available



Lilypad Trolley TR2008



Tables and Chairs



New Design Curved Mobile easy reader with Seating

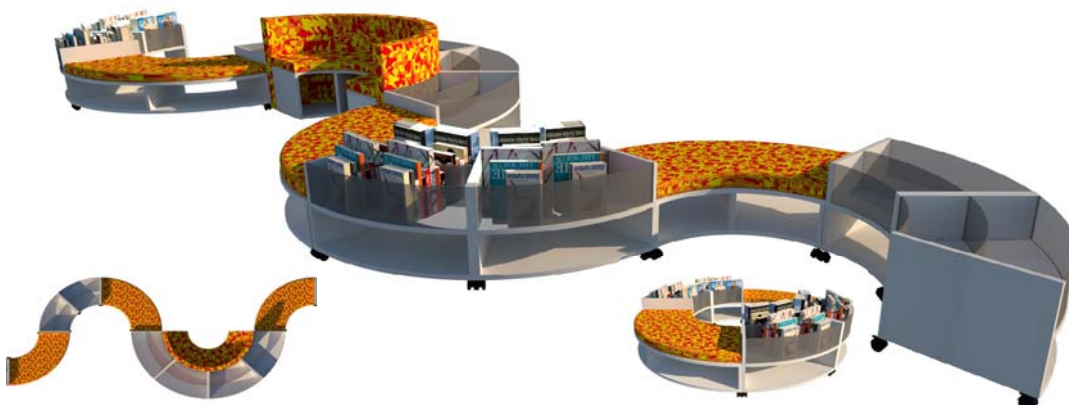

Built in castors for easy flexible spaces
Combine Multiple single units to create unique spaces in your Library

Custom Colours and Fabrics available

Children's Furniture



KATAPILLA JUNIOR CENTRE 1. Book Display Unit FC1174 2. Table Section FC1172 3. Four Section Book Bin FC1173 4. Face and Antlers FC1175

CHARACTER MOBILE EASY READERS



LION FC1192



FROG FC1194



PIG FC1191



DUCK FC1193

Dimensions: 683mmH x 755mmL x 485mmD



TRUCK FC1197

BOOKWORM SET

FC1196

(5 piece set)

Can be purchased individually
685mmH (With castors) x 600mmW x 755mmD



Children's Furniture

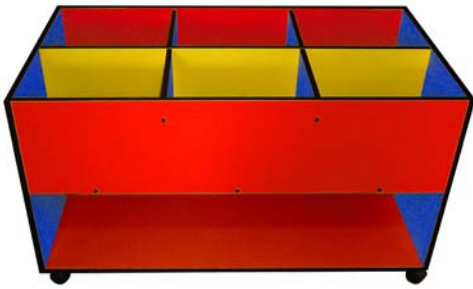

6 COMPARTMENT EASY BOX FC1169MC

670mmH X 1230mmW X 650mmD
Internal dimensions: 300mmH x 382mmW x 300mmD



COLOURED EASYBOX FC1164

560mmH X 760mmW X 760mmD
Internal dimensions: 175mmH x 350mmW x 350mmD



ECONOMY ACTIVITY TABLE FC1070
1200mmW x 900mmD x 500mm H

PLEASE NOTE: ALL MULTI COLOURED FURNITURE IS ASSEMBLED WITH RANDOM COLOURED PANELS. SPECIFIC COLOURS AVAILABLE AT AN ADDITIONAL COST.



EASY READING BOXES CS1161

500mmH X 760mmW X 760mmD (Including castors)
Internal dimensions: 175mmH x 350mmW x 350mmD
Also available without castors CS1160



CHUNKY TUBE ACTIVITY TABLES
With lift out centre for storage tub.



CHILDREN'S ACTIVITY CHAIRS CH2300

Available in assorted colours
300mmW x 300mmH x 300mmD
Also available with fabric seats CH2301



CHUNKY TUBE DISPLAY/STORAGE CS1080

600mmH X 900mmW X 600mmD
Stores approx up to 50 books per compartment

Big Book Storage

BIG BOOK STORAGE

Black metal frames with castors. Removable white plastic coated wire BIG BOOK Baskets. (capacity approx. 30-60 books)
Basket overhang frames by 3mm. Heights include castors.

Basket and Stand may be sold Separately.

BIG BOOK BASKET WI9220

Basket dimensions: 600mmH x 650mmW x 200mmD



ONE TIER

SS 750mmH x 540mmW x 290mmD
DD 750mmH x 540mmW x 605mmD



SINGLE SIDED
FS2153A

1540mmH x 540mmW x 290mmD

TWO TIER

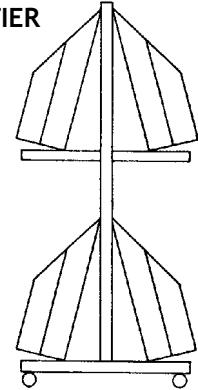

DOUBLE SIDED
FS2154A

1540mmH x 540mmW x 605mmD

MOBILE CHART FILE FS2120

Tubular steel frame on castors 900mmW x 700mmH (200mmD)
Fits up to approx 120 dividers. (200mmD)

Additional sleeves and cardboard dividers available.

Sleeves - HB3140
Cardboard Dividers - ST2480



HANGING CHART FILE SYSTEM



HANGING CHART FILE RACK

May be wall mounted
or assembled with a stand.
Available in two widths—700mm and 1200mm

700mm Wide FS2301
1200mm Wide FS2302

Supplied with one roll punched adhesive tape
per wall mounted rack.
Fits approx 150 charts per rack

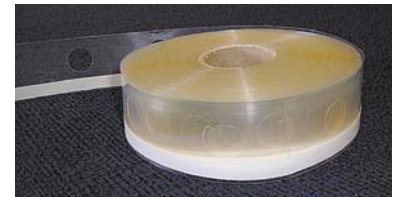

PUNCHED ADHESIVE STRIP
ST2303

SINGLE SIDED STAND SET

includes 1 rack and
1 roll of adhesive tape
700mm Wide FS2304A
900mmH x 700mmW x 308mmD
1200mm Wide FS2305A
900mmH x 1200mmW x 320mmD

DOUBLE SIDED STAND SET

includes 2 racks and
1 roll of adhesive tape
700mm Wide FS2306A
900mmH x 700mmW
1200mm Wide FS2307A
900mmH x 1200mmW



HANGING CHART FILE STAND

Available in two widths—700mm and 1200mm
Castors and optional extra.

SINGLE SIDED STAND stand only

700mm Wide FS2304
900mmH x 700mmW x 308mmD
1200mm Wide FS2305
900mmH x 1200mmW x 320mmD

DOUBLE SIDED STAND stand only

700mm Wide FS2306
900mmH x 700mmW
1200mm Wide FS2307
900mmH x 1200mmW

Stand also available - sold separately. All Racks and Stands are supplied in a BLACK powdercoated finish only.

Furniture - Storage



3 TIER AV STAND-FS2200
1800mmH x 900mmW x 600mmD
Capable of carrying approx.
300 poly bags

BIG BOOK HANGING FRAME FS2101
Not pictured
20 Capacity
965mmH x 900mmW

Available with
or without
castors.

Black only

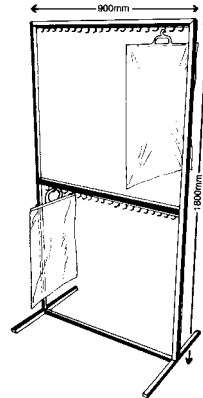

BIG BOOK HANGING FRAME FS2100
40 Capacity
1800mmH x 900mmW x 600mmD
Including castors.

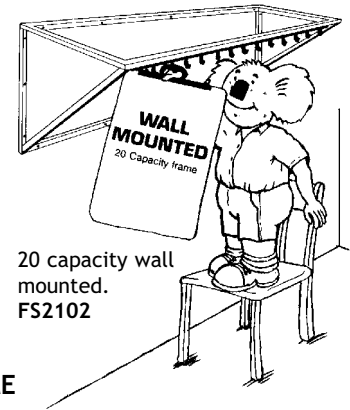

20 capacity wall
mounted.
FS2102



AV POLY BAGS
HB3171 Size 1 25cmW x 25cmD
HB3172 Size 2 36cmW x 36cmD
HB3173 Size 3 25cmW x 36cmD



CONVERTER HOOK ST3010
*Required to hang Big Book Hanging Bags on AV Stand



BIG BOOK HANGING BAGS *
HB3040 Size 4 40cmW x 55cmD
HB3050 Size 5 45cmW x 60cmD
HB3060 Size 6 55cmW x 65cmD
HB3070 Size 7 30cmW x 40cmD



PROJECT STAND WI9100
1260mmH x 740mmW x 560mmD
With 4 display shelves



FC1150

BIG BOOK UNIT
Pictured Unit: 1575mmH x 600mmW x 400mmD
Top partitions internal space: 566mmH x 175mmW
Bottom partition internal space: 271mmH x 564mmW

BIG BOOK UNIT FC1151
Made to order with 6 or more
adjustable shelves.
Pictured Unit:
1800mmH x 680mmW x 500mmD
Internal space:
542mmH x 200mmW



Steelco

FILE CABINETS Standard colours: White Satin, Graphite, Silver Grey, Burgundy, Beige & Black



FI4010
2 DRAWER

FI4020
3 DRAWER A4

FI4020
3 DRAWER A3

FI4030
4 DRAWER

LATERAL FILE CABINETS Standard colours: Silver Grey, Beige & Graphite



FI4072
2 DRAWER
710H x 915W x 620D

INSERTS FOR DVD's -CD's-
MICROFLM & MICROFISCHE P.O.A.

FI4073
3 DRAWER
1015H x 915W x 463D

FI4074
4 DRAWER
1320H x 915W x 463D
ADD FI4076
FLIPPER (AS PICTURED)

FI4812
7 DRAWER MULTI
MEDIA CABINETS
1320H X 790W X 620D

FI4822
10 DRAWER
MICROFILM CABINET
1370H X 790W X 620D

FI4110
6 DRAWER PLAN CABINET
628H X 1375W X 960D
STAND 250H X 1375W X 960D

STATIONERY CABINETS



FI4152 1015H x 914W x 463D
FI4151 1830H x 914W x 463D
FI4153 2000H x 914W x 463D



Standard colours:
Graphite , Silver
Grey, Burgundy,
Beige & Black.

Special colours by
arrangement

SLIDING DOOR CABINETS Standard colours: Silver Grey, Beige & Graphite



SLIDING GLASS DOOR CABINETS

- FI4300 1015H x 914W x 465D [1 shelf]
- FI4302 1830H x 914W x 465D [3 Shelves]
- FI4301 1015H x 1500W x 465D [1 Shelf]
- FI4303 1830H x 1500W x 465D [3 Shelves]
- FI4313 ADDITIONAL SHELVES [Inc Clips] 914W
- FI4314 ADDITIONAL SHELVES [Inc Clips] 1500W

SLIDING STEEL DOOR CABINETS

- FI4308 1015H x 914W x 465D [1 shelf]
- FI4310 1830H x 914W x 465D [3 Shelves]
- FI4309 1015H x 1500W x 465D [1 Shelf]
- FI4311 1830H x 1500W x 465D [3 Shelves]
- FI4313 ADDITIONAL SHELVES [Inc Clips] 914W
- FI4314 ADDITIONAL SHELVES [Inc Clips] 1500W

LOCKERS Standard colours: Silver Grey, Beige & Graphite



- FI4161 1D 1830H x 380W x 460D
- FI4162 2D 1830H x 380W x 460D
- FI4163 4D 1830H x 380W x 460D
- FI4164 6D 1830H x 380W x 460D
- FI4165 8D 1830H x 380W x 460D

Trolleys

DESIGNED TO CONFORM TO WORKPLACE HEALTH AND SAFETY REQUIREMENTS



1. ARMIDALE FLAT SHELF TROLLEY TR2011
2. ARMIDALE SLOPING SHELF TROLLEY TR2021

Half size book trolley.

Dimensions: 1110mmH x 500mmW x 500mmD
Distance between shelves: 320mm



CATALOGUING TROLLEY TR2030

Dimensions: 1100mmH x 450mmW x 570mmD
Shelves set at a 20° angle
Distance between shelves: 340mm

Unless specified, Trolleys will be supplied in White Birch
Black or Oyster available at no additional charge.
A COLOUR FEE IS CHARGED FOR NON-STANDARD COLOURS.



BRISBANE SLOPING SHELF TROLLEY TR2013

Dimensions: 1105mmH x 650mmW x 500mmD
Distance between shelves: 370mm



NEW

Adjustable trolley dividers with magnetic rubber under to stop slip.
TRSDIV



BRISBANE FLAT SHELF TROLLEY TR2012

Dimensions: 1105mmH x 650mmW x 500mmD
Distance between shelves: 370mm

ALL QLS TROLLEYS HAVE TUBULAR STEEL FRAMES AND ARE FULLY BRACED BENEATH THE BOTTOM SHELF

Trolleys



SINGLE SIDED 2 SHELF BOOK TROLLEY TR2015
 Dimensions: 1110mmH x 650mmW x 400mmD
 Distance between shelves: 420mm

ALSO AVAILABLE 850mm WIDE TR2014
 Handles optional (50mm wide) Not included in price



SINGLE SIDED BOOK TROLLEY TR2060

Dimensions: 1110mmH x 850mmW x 400mmD
 Distance between shelves:
 1st & 2nd—325mm
 2nd & 3rd—335mm



1. METAL FLAT SHELF TROLLEY TR2010
2. METAL SLOPING SHELF TROLLEY TR2020

Dimensions: 1110mmH x 850mmW x 500mmD
 Distance between shelves: 320mm

3. TWO SHELF TROLLEY WITH FIXED DIVISIONS*
 Flat: TR2016
 Sloping: TR2022



GRAVITY TROLLEY*
 Two shelf gravity trolley for easy access
 1200mmH x 820mmW x 350mmD
 Distance between shelves: 300mm



SORTER TROLLEY
 Two or three bin wide trolley to hold six or nine bins. Ideal for collecting inter-library returns.



BRISBANE TROLLEY
 With vinyl overlay on shelves.
 Adhesive backed vinyl available as a retrofit

*Custom colour pictured additional charges apply

REDUCE NOISE WITH VINYL OVERLAY

Trolleys



STERLING FLAT SHELF TROLLEY TR3010
Metal frame with melamine shelves and end panels.

Stock standard colours: Black Frame and Beech Melamine
Colours may be customised to suit your needs

Dimensions: 1110mmH x 850mmW x 500mmD
Distance between shelves:
1st & 2nd—335mm
2nd & 3rd—320mm



STERLING SLOPING SHELF TROLLEY TR3020
Metal frame with melamine shelves and end panels.

Stock standard colours: Black Frame and Beech Melamine
Colours may be customised to suit your needs

Dimensions: 1110mmH x 850mmW x 500mmD
Distance between shelves:
1st & 2nd—340mm
2nd & 3rd—320mm



NEW
A3 Poster Display for Trolleys BH1000



RETURNS TROLLEY WITH BIN TR2200

1. & 2. Custom made TR2200M
3. Standard
Dimensions:
695mmH x 425mmW x 840mmD
Bin size:
415mmH x 400mmW x 645mmD



MOBILE KIT HOLDER TR2300

Black only. Fits 10 x size 4 tubs
Height including castors: 1225mmH
Size 4 tubs **ST5801**
Size: 130mmH x 420mmW x 320mmD
Colours: White, Blue or Orange



BUSY BASKET TROLLEY TR4043
Chrome Plated - holds 2 standard Busy Baskets (sold separately)

Dimensions:
910mmH x 410mmW x 660mmD
Basket Dimension:
70mmH x 390mmW x 470mmD
In between height: 75mm
BUSY BASKETS BB5850



Super strong plastic. Independently tested to carry over 100kgs.

Dimensions:
320mmH x 420mmW x 230mmD
Capacity: 20 Litres
Colours: Red, Blue, Black, Green and Yellow. (subject to availability)

Trolleys



REDCLIFFE TROLLEY TR2040
Stack for storage
Silver colour only
Dimensions:
920mmH x 500mmW x 460mmD



MAKE-A-SPACE TROLLEYS with storage shelves below



MAKE-A-SPACE TROLLEYS are made to order and are available with custom colour frames and board. Lift up sides to increase work area. Three x power points with Elsafe Software approved pluto point.



SINGLE BASKET CUSTOMER TROLLEY - TR2700



TWO BASKET CUSTOMER TROLLEY - TR2701



FLATBED TROLLEY TR4120
With collapsible handle
Shelf dimensions: 740mm x 480mm
Weight Capacity 150kg

Flat Screen TV Trolley



Flat screen Mount included which can be set at 5 different heights



Optional Laptop/iPad Arm TR3012SAS

Optional Storage or DVD Shelf TR3012SH



Laptop/iPad Shelf has 3 different heights and can be used on left or right hand sides.

Electric Height Adjustable Trolley TRE3012SH (Also available, not shown)

With 2 lockable 125mm wheels



Signage

BIG SIGNS Custom made area identification signs



LASER-CUT METAL SIGNS Sizes - styles & colours to order



LASER-CUT MELAMINE SIGNS Sizes - styles & colours to order



Wallmount, Moveable and hanging Signs
Custom sizes and colours available.
Powdercoat to suit your colour surface.
Check our website or speak with one of our representatives for price and availability.



Metal Sign Holders with Clear Acrylic Covers
4 sizes: A4, A5, 260mm x 120mm and 400mm x 120mm
Powdercoated to suit your colour surface.



Display Boards

WALL MOUNT COMMUNICATIONS BOARDS



LOCKABLE NOTICE BOARDS
Timber Frame, toughened safety glass

Standard Sizes

900 x 600	1500 x 900	2400 x 900
900 x 900	1500 x 1200	2400 x 1200
1200 x 900	1800 x 900	
1200 x 1200	1800 x 1200	

PINBOARDS - CORK OR FABRIC
PLUS White Boards - Wall Mount and Mobile

Standard Sizes	2400 x 900
900 x 600	1800 x 1200
1200 x 900	2400 x 1200
1500 x 900	
1800 x 900	Other sizes to order



WHITE BOARDS

Wall mounted and Free Standing



**FIXED MOBILE
DOUBLE SIDED
WHITEBOARD**
Commercial or Porcelain
Choose from a range of
surfaces and sizes.

COLOUR MATCH SCREENS

1550mmH (inc feet) x 1200mmW **FS2051**
1550mmH (inc feet) x 1800mmW **FS2052**
Made to order

Standard Sizes:
900mm x 600mm
900mm x 900mm
1200mm x 900mm
1800mm x 900mm
1200mm x 1200mm
1500mm x 1200mm
1800mm x 1200mm
2400mm x 1200mm

**PIVOTING MOBILE
DOUBLE SIDED
WHITEBOARD**
Commercial or
Porcelain
Choose from a range
of surfaces and
sizes.



Communication Boards



A1 DOUBLE SIDED MAGNETIC WHITEBOARD WB2671
(White only)
Supplied with 2 x UV2 Clear Covers.
Suitable for Posters, Magnetic Lettering and Whiteboard Pen acceptable only
And Magnetic letters.



LOBBY BOARD WB2673
(White only)
Supplied with 1 x UV2 Clear Cover
Suitable for Posters and Magnetic lettering only



A1 DOUBLE SIDED MAGNETIC CHALKBOARD WB2670
Supplied with 2 x UV2 Clear Covers.
Colours available:
Black, Yellow, Dark Blue, Red, Light Blue, Green
Suitable for Magnetic letters and Liquid Chalk Only



MAGNETIC LETTERS
(300 characters approx.)
Small 60mm letter size **WBA2679**
Medium 86mm letter size **WBA2681**
Large 120mm letter size **WBA2680**
LETTERS: BLUE and BLACK only
NUMBERS: RED only
SYMBOLS: RED, BLUE and BLACK



LIQUID CHALK WBA2682
White, Blue, Pink, Green, Yellow and Purple

Expanda - Flexible Brochure Display

BH8220
Universal wall bracket

BH8071
Connector & sign holder

BH8070
Universal base stand

BH8210
Trifold brochure holder

BH8020
A5 brochure holder

BH8010
A4 brochure holder

SWBRACKET
Wire adaptor for slatted walls & peg board

Wall mounted bracket attachment

Brochure holders with connector sign holder

Base stand assembly

BH8011
Business card holder (desktop)

BH8012FB
Business card holder (flat back)

BH8012V
Vertical business card holder (clip on)

BH8012
Business card holder (clip on)

Diagram of slatted wall attachment using wire adaptor

Aluminium Wall Bar
895mm BH8060
450mm BH8050
4500mm BH8051

450mm wide
550mm high

BH8234
Trifold wall display

900mm wide
680mm high

BH8232
Combination A4 Trifold wall display

Many other wall display combinations available!

Mounting diagram showing aluminium wall bar with standard base stand for wall support

BH8248
Trolley for 80 Trifold holders

960mm wide
1260mm high

BH8247
Trolley for 40 Trifold holders

480mm wide
1260mm high

BH8246
Trolley for 32 A4 holders

960mm wide
1260mm high

BH8236
Trolley for 16 A4 holders

480mm wide
1260mm high

8 x A4 BH8163
10 x A4 BH8162
16 x A4 BH8161

16 x Trifold BH8166
20 x Trifold BH8167
32 x Trifold BH8168

All Carousels 1650mm high x 610mm wide

BH8140 **BH8249** **BH8170** **BH8230** **BH8160**

Brochure Display System



TOWER UNITS FC1006
Brochure holders additional.
 Any combination of Brochure Holders can be used.
 Can be made to any size, shape and colour required.
 Fabric covered board also available.
 Also available with castors.



CAROUSEL BH8170
 3 tier—18 A4 brochure holders



FOYER STAND BH8241
 12 X A4 brochure holders



CAROUSEL BH8230
 3 tier—18 A5 brochure holders



CAROUSEL BH8140
 3 tier—36 trifold brochure holders

CUSTOMISE YOUR OWN REVOLVING STAND



TROLLEY BH8247
 40 Trifold brochure holders



TROLLEY BH8246
 32 A4 brochure holders



WALL MOUNT BH8233
 32 Trifold brochure holders



WALL MOUNT BH8232
 16 Trifold, 8 A4 brochure holders

Glass Display Cabinets



Glass Display Cabinets

CENTRE TOWER CASE

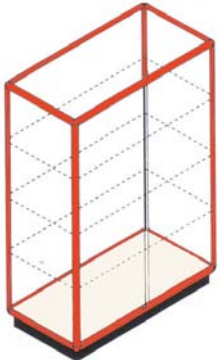

FB5100
1800mmH x 600mmD

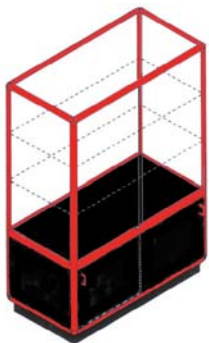

FB5102
1800mmH x 600mmD
With storage Base
Cupboard Height 475mm



METAL - SLIDING GLASS DOOR - CABINETS

Sizes available:
1015mmH x 914mmW x 465mmD
1083mmH x 914mmW x 465mmD
1015mmH x 1500mmW x 465mmD
1083mmH x 1500mmW x 465mmD
Colours available: charcoal - white - light grey

CENTRE TOWER CASE WITH FASCIA

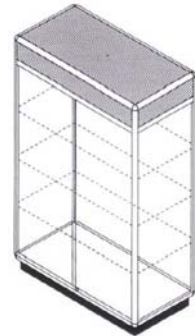

FB5101
2000mmH x 600mmD

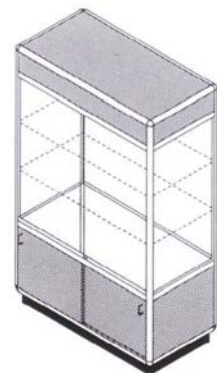

FB5103
2000mmH x 600mmD
With Storage Base
Cupboard height 475mm

WALL MOUNTED CASE



FB5108
1000mmH x 300mmD
**No lighting option
Also available in 900mm Wide



FB5109
1200mmH x 300mmD
Also available in 900mm Wide

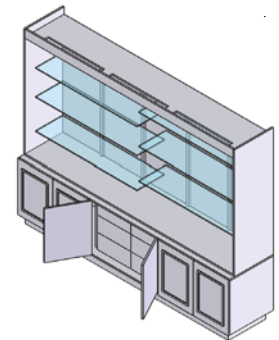

WALL STANDING CASE—Must be fixed to a wall for stability. Timber Back



FB5104
2000mmH x 600mmD

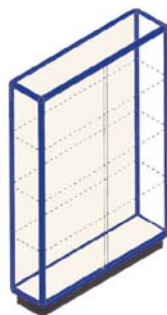

FB5105
1800mmH x 600mmD

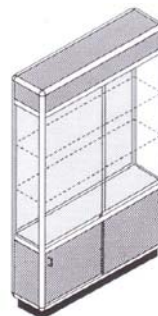

FB5106
2000mmH x 600mmD
With Storage Base
Cupboard Height 475mm



FB5107
1800mmH x 600mmD
With Storage Base
Cupboard Height 475mm



QL
QUANTUM
LIBRARIES

Toll Free Phone: 1800 773 374
Toll Free Fax: 1800 068 944
Email: info@quantumlibraries.com.au

Head Office
Address: Unit 1, 135 Ingleston Road,
WAKERLEY QLD 4154
PO Box 4452 Gurdale QLD 4154

Australia Wide Email Ordering: sales@quantumlibraries.com.au
Local Buy Contract - Library Resources (Goods and Services) BUS255-0116